

WHOLE HOUSE

iSpring WGB21B Series Heavy Duty Water Filtration Systems

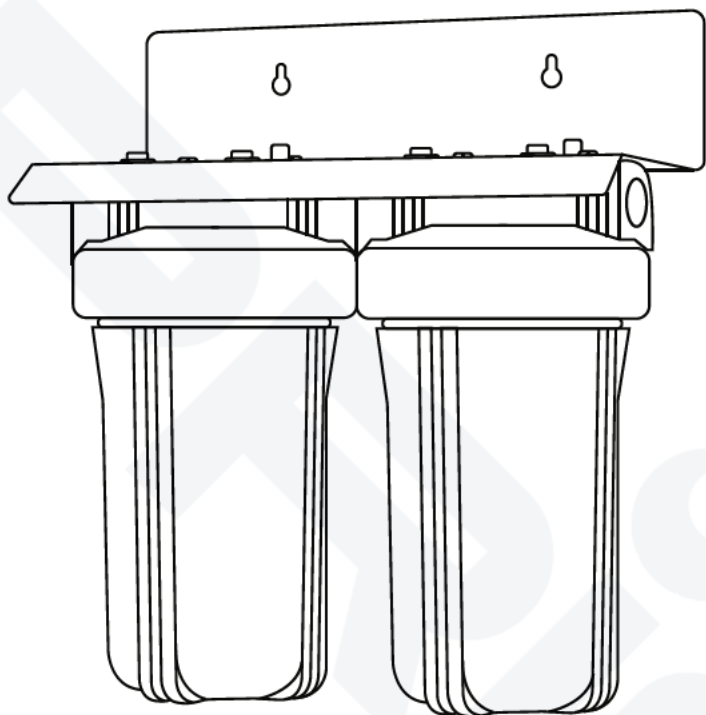

Installation Instructions & User Manual

Ver. 07/2021



iSpring Water
Systems



Copyright ©2005-2021 ISPRING WATER SYSTEMS, LLC. All rights reserved.



Thank you for choosing iSpring Water Filtration Systems! Built from quality components and delivering exceptional performance, this system is designed to provide you and your loved ones with a continuous on-demand supply of clean and refreshing filtered water for many years to come.

This manual includes the necessary information on how to properly install, operate, and maintain your iSpring Water Filtration System.

Please keep this manual for future reference.

Attention Installers

DO NOT use petroleum based lubricant on o-rings.

DO NOT use white plumber's grease or faucet/valve lubricant on o-rings.

O-rings that ship with this system are pre-lubricated and ready for installation.

When additional lubrication is needed, please contact us at 678-261-7611 (M-F, 8:30 - 5:30 EST) or email us at support@ispringfilter.com.

Fitting Installation

Depending on the actual size of the pipe, up to 12 - 15 wraps of plumber's tape might be required to seal the pipe connections. Apply 6 - 7 wraps of tape and press into threads without cutting. Apply 6 - 7 more wraps and neatly form before installation.

Plumber's tape can be purchased on our website at www.123Filter.com.

Table of Contents

Product Specifications	1
Specifications	1
Component List	1
Tools Required	1
Parts Required (Not Included)	2
Installation Instructions	2
Installation Overview	2
Pre-installation Notes	2
Pre-installation	3
Installation	3
Maintenance Instructions	7
Filter Change Instructions	8
Troubleshooting	9
Frequently Asked Questions	10
Warranty	11
Warranty Registration Form	13

Product Specifications

Specifications

Model	WGB21B Series
Flow Rate	3 - 15 GPM
Peak Flow Rate	15 GPM
Minimum Working Pressure	25 psi
Maximum Working Pressure	80 psi
Operating Temperature	40 - 100 °F (4 - 37 °C)
pH Range	6.0 - 9.0

Component List

Part	Description	Qty
System bracket with caps	Metal bracket with 1" NPT inlet /outlet Black caps	1
Housing	Housing with o-rings Model # HB18B (WGB21B series)	2
Cartridges	PP sediment, CTO carbon block or metal removal filter Model # FP15B / FC15B(WGB21B) Model # FC15B / FM15B (WGB21BM) Model # FC15B / FCRC15B (WGB21B-PB)	2
Wrench	Housing wrench Model # AWR3	1

Tools Required

Safety glasses	Hacksaw
Towels	Soldering iron or torch
Flat head screwdriver	Adjustable wrench
Medium Crescent wrench	Plumber's tape

Parts Required (Not Included)

- (4x) Shutoff valves
- (2x) Hex nipples or pipe nipples
- (2x) Pipe union pressure regulators (as needed)
- (1x) Ground jumper cable

Installation Instructions

Installation Overview

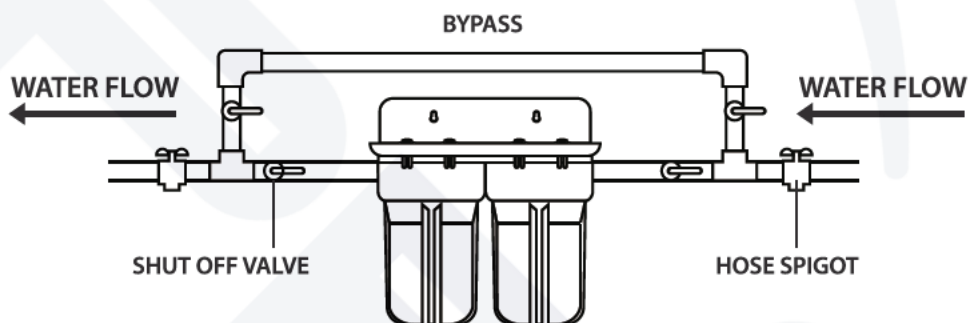

Model	Stage 2	Stage 1
WGB21B	Carbon Block Filter FC15B	PP Sediment Filter FP15B
WGB21BM	Iron/Manganese Removal Filter FM15B	Carbon Block Filter FC15B
WGB21B-PB	Lead/Iron Removal Filter FCRC15B	Carbon Block Filter FC15B

Pre-installation Notes

- This installation guide provides a step-by-step, start-to-finish procedure for installing your iSpring whole house water filter. All steps provided herein are for typical installations only. Your specific application may vary.

- The filter should be kept in a sheltered location and should never be exposed to freezing or extreme temperatures and direct sunlight. Such damage is not covered under any warranty.
- Be sure to note the inlet/ outlet markings and the water flow direction.
- A three-valve bypass valve and loop may be installed to loop the entire system to make servicing easier.
- Hard copper pipes generally come in two types. Use the thicker "L" type copper pipe rather than thinner "M" type copper pipe.
- Follow all local plumbing and building codes.

Pre-installation

- Turn off the water supply to your house before beginning the installation.
- Turn off power to your water heater before installation.
- Open all plumbing fixtures in the house to drain any water and release the pressure in pipelines.
- Lay out all the fittings and tools you will need to install the system depending on your configuration.
- Be sure to use plumber's tape on threaded fittings.

Installation

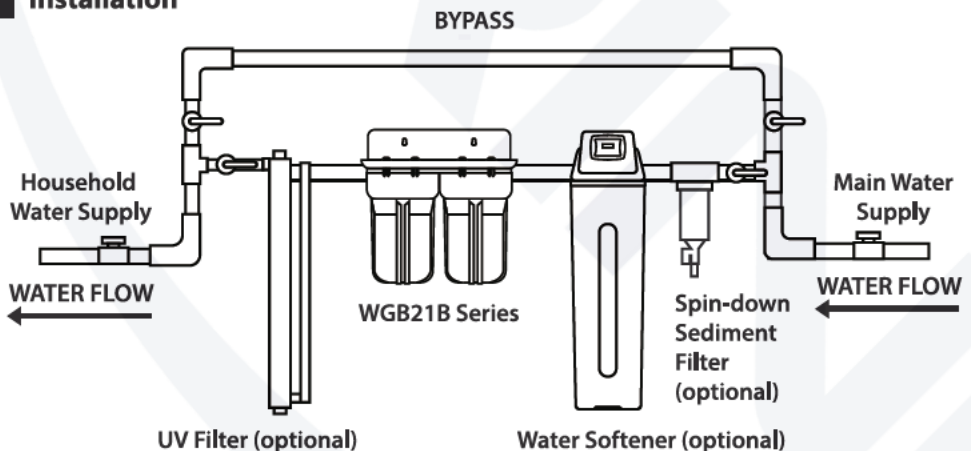

- The filter should be placed on the main water supply line near where it enters the house at any point past the main shutoff valve for the whole house, but before pipes branching off into multiple directions. **The whole system should be located in a dry, level area and protected from freezing or extremely high temperatures and direct sunlight.**



Notice:

WGB21B series comes with a 1" NPT Female inlet/outlet. A shutoff valve is recommended prior to the system.

Step 1 - Measure the System and Cut the Pipe

- Determine the location and water flow direction for the system.



Notice:

If the water flow of the pre-installed caps union points conversely to your water flow, you can converse the caps union by unscrewing the bolts that connect it with the bracket.

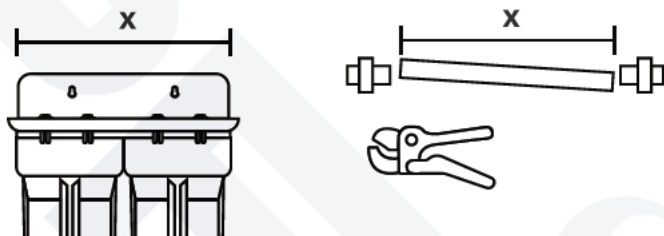

- Measure, cut, and remove the section of water line where the system is to be installed. When determining the length of pipe to cut, consider filter width, shutoff valves, union fittings, nipple fittings, pressure gauges (if used) and bypass valve (if used).
- Allow the cut line to drain. Smooth the newly cut ends down to avoid jagged points or edges.

Step 2 - Mount the Filter Bracket

- Securely mount the whole house filter bracket and ensure the system is level.
- Attach your plumbing to the INLET and OUTLET with 1" male NPT threaded adapters for your system.

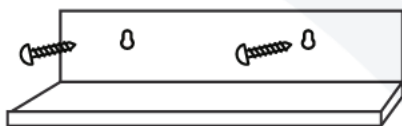

Step 3 - Add Shutoff Valve and/or Pressure Gauge (Optional)

- Place a shutoff valve and/or a pressure gauge on either side of the filter for the ease of monitoring and convenience of service.

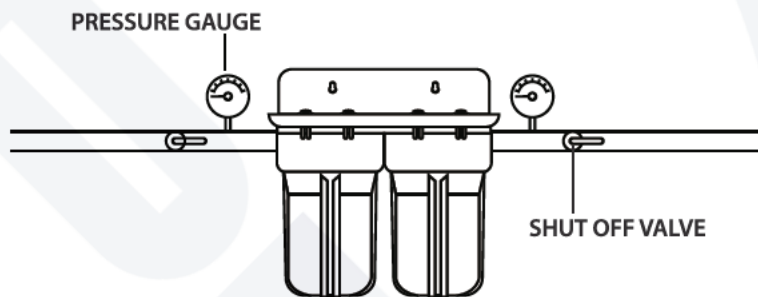

- You may need to adjust pipe length or distance. Fit a pipe union onto the cut section of the main water line.
- Fit together the pipe union and shutoff valve. Use plumber's tape on threaded fittings.
- Fit together the shutoff valve and whole house filter system using a pipe nipple or hex nipple to draw them together on the FEED/INLET side of the filter.
- Next, fit together the filter system and the shutoff valve on the OUTLET side of the filter. Fit the pipe union to shutoff valve on the OUTLET side.
- Check pipe length and pipe union length to see if additional pipe length or union is needed. Join the pipe union and the pipes.
- Put pipe hanger on water INLET and OUTLET side for additional pipe support.

Step 4 - Add Ground Jumper Wire(Optional)

- Connect ground jumper wire (if necessary).

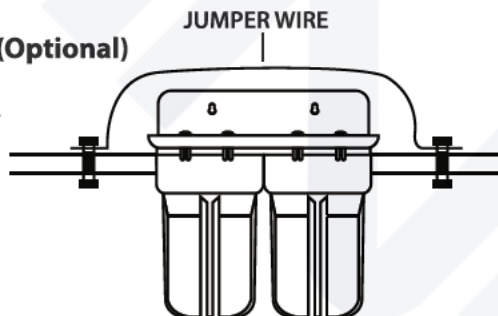

Step 5 - Filter Cartridges and Housing Assembly

- Unwrap sealed cartridges and insert each into each of the housing centering on the standpipe.
- Hand tighten the Blue Filter Housing. Then, using the supplied Filter Wrench, lightly snug the housing while making sure not to over-tighten.

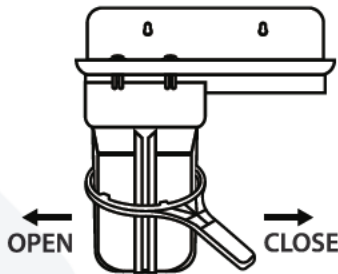

Step 6 - Turn on Water Supply and Flush the System

- Slowly turn on water main to fill the housing. After a few minutes, the sound of water entering the system will stop.
- Check for leaks.
- Open the nearest COLD water faucet and run water for about 10 minutes to expel possible carbon fines.



CAUTION:

Do not use a hot water faucet to perform the initial system flush.



NOTICE:

The water could be blackish in color for the initial flush. This is residual carbon dust and is to be expected. Continue to run water until it runs clear and all air has been purged. Shut off the water and let the system sit for a while, and then flush again. It is not unusual for the water to appear "cloudy" for a day or so following installation. This cloudiness is actually tiny air bubbles being purged from the filters. This is normal and will clear up in a day or two.



NOTICE:

After prolonged periods of nonuse (such as a vacation), it is recommended that the system be flushed thoroughly for at least 10 minutes before using the water.

Step 7 - Turn off the Faucet and Your System is Ready for Use

! NOTICE:

Even though there is filtered water in the cold water lines, the hot water heater is still full of unfiltered water. Through normal use, this water will be replaced with filtered water in about 2 or 3 days.

Maintenance Instructions

Your iSpring Whole House Water System requires care and cleaning after a period of time. It is recommended that the cartridges be replaced every 6-12 months depending on the quality of source water. If the system has been working properly and the filtered water output is slowing down, it may be time to change the filter cartridges.

Replacement cartridges and parts can be ordered online at www.123Filter.com or by calling 678-261-7611 (M-F, 8:30 - 5:30 EST).

Chart of Model Numbers for Replacement Cartridges

	PP Sediment Filter	Carbon Block Filter	Iron/Manganese Removal Filter	Lead Removal Filter	Filter Pack
System Model#	FP15B	FC15B	FM15B	FCRC15B	--
WGB21B	●	●	○	○	F2WGB21B (FP15BX1, FC15BX1), F4WGB21B (FP15BX2, FC15BX2)
WGB21BM	○	●	●	○	F2WGB21BM (FC15BX1, FM15BX1)
WGB21B-PB	○	●	○	●	F2WGB21B-PB (FC15BX1, FCRC15BX1)

- This filter is designed for this system and included in the original system package.
- This filter can apply to this system, even though it is not included in the original package.

Filter Change Instructions

Part 1 - Remove the Old Cartridge

- 1.1 Turn off the water supply to the system. Open a nearby faucet to release the pressure and drain the water.
- 1.2 Press the red pressure release button on the top of the filter housing to release system pressure. This will make removing the filter housing easier.
- 1.3 Unscrew the housing using the filter wrench included (AWR3) with your system, or a commercially available “strap” type wrench.
- 1.4 Locate and remove the large O-ring using a small, clean flat head screwdriver. Try not to remove any of the lubricant. Set it aside in a clean, safe place.
- 1.5 Remove and discard the old filter cartridge.

Part 2 - Clean the Housing

- 2.1 Clean the housing and cap with lukewarm water mixed with about 2 tablespoons of household bleach using a sponge or soft cloth. Wear rubber gloves. **Rinse all parts thoroughly.**
- 2.2 Lubricate the O-ring with clean silicone grease if needed. **Do not use petroleum jelly.** Insert the O-ring in filter groove and press into place. **Make sure the O-ring is seated correctly.**

CAUTION:

This step is important to ensure the proper filter seal. Make sure the O-rings (ORB) are seated level in the groove. If the O-ring appears damaged, stretched, or crimped, it should be replaced.

Part 3 - Install the New Cartridge

- 3.1 Remove the new filter packaging and insert the filter cartridges into the housing, making sure they slip over the standpipe at the bottom of the housing.
- 3.2 Align the bottom of the housing into the cap and hand tighten, then use the filter wrench (AWR3) to fit it snugly. **Do not over-tighten.**
- 3.3 Close any open valves. Turn on the water supply slowly to allow the system to fill with water. **Inspect carefully for leaks.** If a leak is found, remove the housing and inspect the O-ring to ensure that it is seated properly, and then retighten.

Part 4 - Flush the System

4.1 Flush the system by turning on a few cold water faucets. Allow the water to run until the air and carbon has been purged. Water may be cloudy initially as the system needs to clear trapped air. New activated carbon filter cartridges may contain loose carbon and air bubbles after installation. They usually go away within a few days.

Troubleshooting

Problem	Solution
Water pressure is dropping after a period of time	It is recommended that the cartridges be replaced every 6-12 months depending on the quality of source water. If the system has been working properly and the filtered water output is slowing down, it may be time to change the filter cartridges.
Water pressure is dropping immediately after installation	1) The cartridges may be installed incorrectly. Check to see if a piece of the plastic wrapping is still protecting the filter cartridges. 2) Bathtubs, utility sinks, hose bibs, multi-headed showers, body spray showers, or anything that is considered high-flow should be avoided for the first 72 hours. Any high-flow situation within the first 72 hours may cause a temporary carbon blockage. To clear the blockage, turn off any running water for at least 10 minutes and resume using water at low or normal flow rates.
Water appears cloudy and grey	Water might appear cloudy or grey for the first 3-5 days after installation due to the tiny air bubbles being purged from the filters and extra carbon dust in the water.
Leaking from the red button	The red button has a screw under the bracket. Simply tighten that screw and the leaking should stop.
Leaking from the housing connection	The O-ring may not be in place. If it still leaks after adjusting the O-ring, please contact iSpring Customer Service at 678-261-7611 or email us at support@ispringfilter.com

Frequently Asked Questions

Q: With this whole house system, do I still need to install a water softener if my water is very hard?

A: Yes, a water softener is needed if your source water has a high level of hardness, usually with TDS higher than 700 ppm. Hard water can reduce the lifespan of whole house water filter cartridges. The harder the water, the greater amount of scale buildup occurs, and the sooner the filters get clogged.

This whole house water filter can remove 95% of sediment, chlorine, dirt, and various other contaminants that a regular water softener can't; however, it does not soften your water. It is recommended that you install this WGB21B series whole house system after your water softener to achieve optimal performance if you have hard water.

To determine which product best suits your needs, it is recommended that you get a professional water test done prior to purchase to identify the main issue of your source water.

⚠ NOTE:

Whole house systems usually DO NOT lower the TDS level of the water. An additional Reverse Osmosis system may be necessary for your drinking water. Please consult iSpring professionals prior to purchase if you are unsure of which product will meet your needs.

Q: What type of Whole House Water Filter do I need?

A: If you are on municipal water that isn't contaminated with heavy metals like iron, manganese, and lead, the WGB21B is the system to go with. Naturally occurring metals are commonplace in most well water sources, however, and that is where the WGB21BM or WGB21B-PB earns its keep. If you are on well water or have heavy metals in your municipal water supply, you may want to consider the WGB21BM for iron and manganese removal and WGB21B-PB for lead reducing over the WGB21B. For removing the common contaminants found in the majority of municipal water supplies, however, the WGB21B fits the bill.

Q: What flow rate should I look for?

A: Measured in gallons per minute (GPM), flow rate determines the amount of water available to run your shower, toilet, hot water heater, dishwasher, etc. When calculating your requirements, look at the demand ratings printed on your appliances and toilet. Depending on the size of your house and family, your water flow rate requirements may range from 5 to 40 GPM.

Warranty

Visit www.123Filter.com to complete the warranty registration form online.

iSpring 1-Year Limited Warranty

This 1-Year Warranty extends to the original purchaser of the system only. This warranty only covers all manufacturer-supplied items that prove to be defective in material, workmanship, or factory preparation. This warranty covers parts only; all labor is excluded from this warranty, including, but not limited to, services related to the removal, replacement, installation, adjustment, maintenance, and/or repair of the unit or its component items. This warranty applies only for the first full calendar year from date of purchase. The following items are excluded from this warranty: Filter Cartridges, and the O-rings that require regular replacement as a result of ordinary usage.

No warranty is made with respect to defects or damages due to neglect, misuse, alterations, accident, misapplication, physical damage, or damage caused by fire, acts of God, or freezing. These warranties apply only to the original registered owner so long as the owner owns the home in which the unit was originally installed. Customer must register their system with iSpring within 90 days of purchase in order to obtain a warranty. Warranty will discontinue after the unit is removed from the location where it was originally installed. Warranty begins on the date of delivery of product to the customer. Improper maintenance of system (i.e. not replacing filters or media) on time will be considered "neglect". Installation of any system on water conditions outside of or beyond the recommended specs of any system voids any warranty.

Disclaimers: This Limited Warranty applies only if the system is installed, used, and maintained in compliance with all instructions and requirements enclosed with the system. This warranty will be void for failure to observe the following conditions:

1. The system is to be used with potable water supply only.
2. Feed water pressure to the unit is no less than 25 psi and no greater than 80 psi.
3. Feed water temperature to the unit must be no less than 40°F and no more than 100°F.
4. Feed water must have a pH between 6 and 11.

While the testing was performed under standard laboratory conditions, actual performance may vary. The Manufacturer does not know the characteristics of your water supply. The quality of water supplies may vary seasonally, or over a period of time. Your water usage may vary as well. The Manufacturer assumes no liability for the determination of the proper equipment necessary to meet your requirements, and we do not authorize others to assume such obligation on our behalf.

This Limited Warranty does not cover any Manufacturer-supplied items that are defective as a result of the use of improper parts, equipment or materials. This warranty does not cover alterations or modifications of the unit or failure of a unit caused by such alterations and modifications.

Incidental and Consequential Damages Limitation: The Manufacturer will not be responsible for any incidental or consequential damages as a result of the failure of this unit to comply with express or implied warranties or any defect in the unit, including but not limited to, lost time, inconvenience, damage to personal property, loss of revenue, commercial losses, postage, travel, telephone expenditures, or other losses of this nature. In case some states do not allow the exclusion or limitation of incidental or consequential damages, you may choose to return the system. If you choose to keep it, you understand this exclusion WILL STILL apply to you.

Owner's Warranty Responsibilities: As a condition of this Limited Warranty, the owner must ensure that periodic maintenance of the system is performed as described in the literature enclosed with the system. Neglect, improper maintenance, abuse, modification, or alteration of the unit will invalidate this warranty. Should your unit develop a defect or otherwise fail to perform in accordance with this warranty, you should contact the retailer from whom the product was originally purchased.

Implied Warranties: The implied at-law warranties of merchantability and fitness for a particular purpose shall terminate on the date one year after the date of purchase.

To register your product for the warranty, visit our website www.123Filter.com and go to the **"Warranty Registration"** tab. This is **the fastest and most convenient** way to get your warranty registration activated.

We provide a **30-day money back guarantee, a 1-year manufacturer warranty, and lifetime tech support** for all of our major water filtration systems. However, we do not access and store order information from websites other than 123Filter.com (including Amazon, Home Depot, Lowes, etc.), so be sure to fill in that information upon registration of your system. If you have any questions or concerns about your product, please call or email us, or submit your feedback in the notes/comments during warranty registration. **Your satisfaction is our business!**

Warranty Registration Form

Name _____

Order# _____

Email _____

Phone _____

Address _____

City _____

State _____

Zip Code _____

Model #/ Serial Number

Purchased at (e.g. Amazon, Home Depot)

iSpring Water Systems, LLC
2480 Industrial Park Blvd, Cumming, GA 30041
678-261-7611

Plumber's information (Optional)

To best serve our customers, we'd like to recommend good plumbers throughout the USA. If you are happy with your installer, please provide their information so that we can pass it on as a courtesy.

Thank you!

Name of the plumbing company used to install your system:

Phone #: (____) - _____ or email : _____
of the technician.



Like our products?
Please show your support by writing a product review on the marketplace where you make your purchase. Even just a quick statement means a lot to us.

Thank you!

iSpringFilter.com



For questions, comments, or technical support, please contact us at:

✉ support@123filter.com

☎ (678) 261-7611

💬 (470) 560-0012

Monday-Friday 8:30 a.m. - 5:30 p.m. EST

Water's Good™